

CRYSTAL SPECIFICATION



Customer : _____
Customer P/N : _____
Agent : _____
Agent Code : _____
SIWARD P/N : XTL571200-A304-002

Customer Approval :

希華晶體科技股份有限公司
SIWARD CRYSTAL TECHNOLOGY CO., LTD.

業務部/ SALE DEPARTMENT
TEL: (04)25347909
FAX: (04)25327885 / 25337396
URL HTTP://www.siward.com.tw

DATE : 2018/03/12

Approved By : Steve Chen

品質保證部/ QUALITY ASSURANCE DEPT.
TEL: (04)25347909 EXT 1340/1341

Checked By : Tom Tang

研發部/R & D DEPT.
TEL: (04)25347909 EXT 1521

Designer : Sally Lin

Address: 1-1, LANE 111, JUNG-SHAN RD., SEC.3, TANTZU HSING, TAICHUNG 427, TAIWAN, R.O.C.

Rev.	Description of Revision History	Date	Designer	Checked By
1	New Publication	2014/12/03	Sally Lin	Tom Tang
2	Tolerance Changed +/- 20 PPM to +/- 10 PPM ; Stability Over Temperature Changed +/- 30 PPM to +/- 20 PPM. (101K1803-006)	2018/03/09	Sally Lin	Tom Tang

CRYSTAL SPECIFICATION

- 1. Description : Quartz Crystal
 - 2. Nominal Frequency : 27.000000 MHz
 - 3. Center Frequency : 27.000000 MHz
 - 4. Dimension & Drawing No. : CSX-3225 ; SXD-00312
 - 5. Oscillation Mode : Fundamental
 - 6. Cutting Mode : AT cut
 - 7. Packing Style : TP-160
 - 8. Measurement Instrument : S&A 250B(Measured FL)
 - 9. Electrical Characteristics :
- [1] Operating Conditions :

Item	Symbol	MIN.	TYP.	MAX.	Unit	Condition
Operating Temperature Range	Topt	-40		85	°C	
Storage Temperature Range	Tstg	-40		90	°C	
Load Capacitance	CL		10		pF	
Drive Level	DL			100	μW	

[2] Frequency Stability :

Item	Symbol	MIN.	TYP.	MAX.	Unit	Condition
Tolerance	dF/Fo	-10		10	ppm	Refer to Center Frequency @25±3°C
Stability Over Temperature	dF/F25	-20		20	ppm	Refer to Operating Temperature
Aging	dF/F25	-3		3	ppm	Per Year

dF/Fo: Frequency Deviation Refer to Center Frequency

dF/F25: Frequency Deviation Refer to 25 °C Frequency

[3] Electrical Performance :

Item	Symbol	MIN.	TYP.	MAX.	Unit	Condition
Equivalent Series Resistance	ESR			60	Ω	@Series
Shunt Capacitance	C0			5	pF	
Insulation Resistance	IR	500			MΩ	@DC 100 Volt

10. Marking : Laser

<p>*MARKING : D ->YEAR C -> MONTH YEAR : 1 2 3 4 5 6 7 8 9 0 CODE : A B C D E F G H J K MONTH: 1 2 3 4 5 6 7 8 9 10 11 12 CODE : A B C D E F G H J K L M</p>	<div style="border: 1px solid black; padding: 10px; width: 80px; margin: auto;"> <p>27.0</p> <p>S DC</p> </div>
--	---

11. Remark :

<p>* The component complies with Moisture Sensitivity Level 1 defined on JEDEC J-STD-020 standard. * Compliant with RoHS and Siward QAD-S-116 Standard.</p>
--

■Note

1.General cleaning solutions or ultrasonic cleaning method may be used to clean our products. However, under certain circumstances, ultrasonic cleaning machine could generate resonance at the oscillation frequency of our products and thus deteriorate the electrical characteristics in devices, and even damage the overall structure of devices. Therefore, verification test is recommended before cleaning.

2.Avoid mounting and processing by Ultrasonic welding this method has a possibility of an excessive vibration spreading inside the crystal products and becoming the cause of characteristic deterioration and not oscillating.

■ DIMENSIONS
 Unit: mm

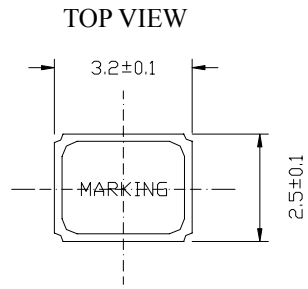

PIN CONNECT	
1,3	Crystal
2,4	GND

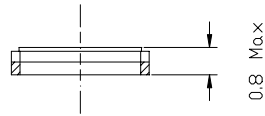

TOP VIEW

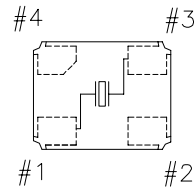

LAND PATTERN (REFERENCE)

BOTTOM VIEW

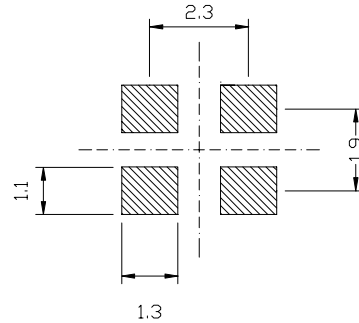
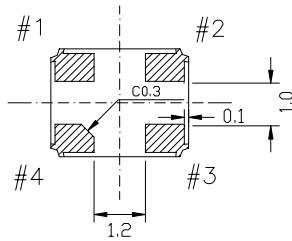

■ STRUCTURE ILLUSTRATION

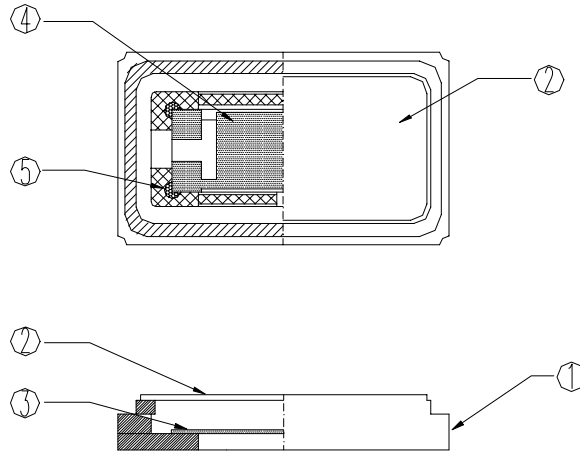

PART NAME		MATERIAL	PART NAME		MATERIAL
1.	BASE	CERAMIC	4.	ELECTRODE	Metal
2.	LID	KOVAR	5.	ADHESIVES	SILVER GLUE
3.	BLANK	QUARTZ			

■ RELIABILITY SPECIFICATION

REFER TO Group A :
 AEC-Q200-REV.D Conforming
 TABLE11-TABLE OF METHOD REFERENCED FOR QUARTZ CRYSTAL

ELECTRICAL & MECHANICAL PERFORMANCE

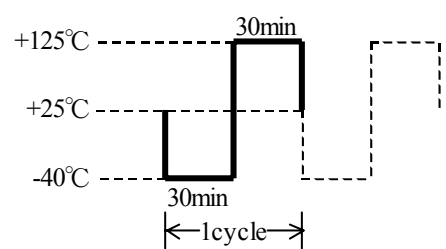
TESTING ITEM		TEST METHOD AND TEST CONDITION
1	Pre-and Post-Stress Electrical Test	Test equipment for crystal unit.
2	TEST NOT USED	-----
3	High Temperature Exposure (Storage) [MIL-STD-202 Method 108]	Temperature : +125°C Time : 1000 hours Measurement at 24±4hours after test conclusion.
4	Temperature Cycling [JESD22-Method JA104]	Temperature Range : -40°C to +125°C Cycle : 1000 cycles 1 min. maximum transition time.  Measurement at 24±4hours after test conclusion.
5	TEST NOT USED	-----
6	TEST NOT USED	-----
7	Biased Humidity [MIL-STD-202 Method 103]	Temperature : +85°C Humidity : 85%RH Time : 1000 hours Tested by oscillation. Measurement at 24±4hours after test conclusion.
8	Operational Life [MIL-STD-202 Method 108]	Temperature : +125°C Time : 1000 hours Tested by oscillation Measurement at 24±4hours after test conclusion.
9	External Visual [MIL-STD-883 Method 2009]	Inspect device construction, marking and workmanship. Electrical Test not required.
10	Physical Dimension [JESD22 Method JB-100]	As per the specification shown on the drawing of external view and dimension.

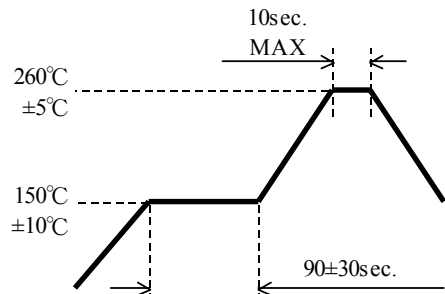
TESTING ITEM	TEST METHOD AND TEST CONDITION								
11 Terminal Strength (Leaded)	This product is of ceramic package. Thus, this test will not be applied.								
12 Resistance to Solvents [MIL-STD-202 Method 211]	Solvent solutions : IPA (Level A or B) With IPA , to scrub the surface of the subject with the brush for 10 times .								
13 Mechanical Shock	<table border="0" style="width: 100%;"> <tr> <td style="width: 50%;">Test Condition</td> <td style="width: 50%;">Test Method</td> </tr> <tr> <td>Half sine wave</td> <td>In accordance with</td> </tr> <tr> <td>Peak value:3000G,0.3ms</td> <td>[MIL-STD-202Method 213]</td> </tr> <tr> <td colspan="2">X,Y,Z each direction 1time</td> </tr> </table>	Test Condition	Test Method	Half sine wave	In accordance with	Peak value:3000G,0.3ms	[MIL-STD-202Method 213]	X,Y,Z each direction 1time	
Test Condition	Test Method								
Half sine wave	In accordance with								
Peak value:3000G,0.3ms	[MIL-STD-202Method 213]								
X,Y,Z each direction 1time									
14 Vibration [MIL-STD-202 Method 204]	<table border="0" style="width: 100%;"> <tr> <td style="width: 50%;">Frequency : 10-55Hz</td> <td style="width: 50%;">Amplitude : 1.5mm</td> </tr> <tr> <td>Frequency : 55-2000Hz</td> <td>Peak value : 20G</td> </tr> <tr> <td colspan="2">Duration time: 4H for each X,Y,Z axis Total 12hours</td> </tr> </table>	Frequency : 10-55Hz	Amplitude : 1.5mm	Frequency : 55-2000Hz	Peak value : 20G	Duration time: 4H for each X,Y,Z axis Total 12hours			
Frequency : 10-55Hz	Amplitude : 1.5mm								
Frequency : 55-2000Hz	Peak value : 20G								
Duration time: 4H for each X,Y,Z axis Total 12hours									
15 Resistance to Soldering Heat [MIL-STD-202 Method210]	Test condition : B Solder bath Temperature : $260\pm 5^{\circ}\text{C}$ Time : $10\pm 1\text{sec.}$								
16 TEST NOT USED	-----								
17 TEST NOT USED	-----								
18 Solderability [J-STD-002]	Perform test as per this reflow profile for one cycle. 								

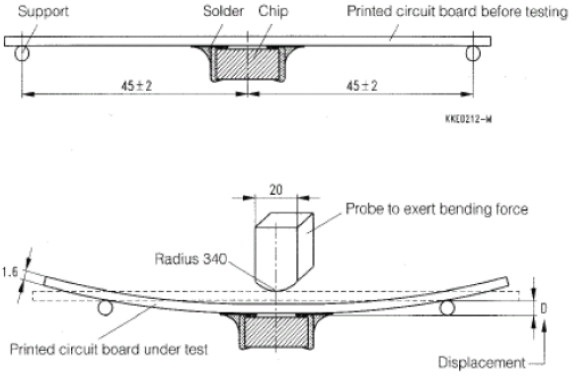
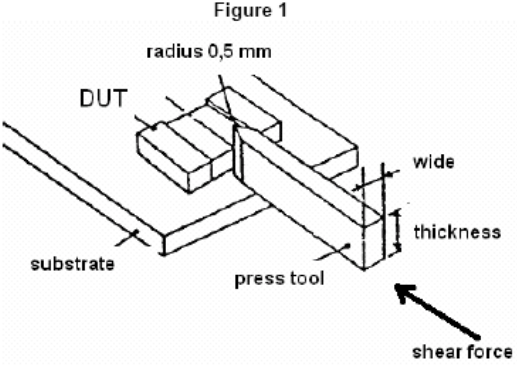
TESTING ITEM	TEST METHOD AND TEST CONDITION
19 Electrical Characterization	Satisfied with electrical performance. Sample data is Min. Max, Mean and Standard deviation
20 Flammability	This product is of ceramic package. Thus, this test will not be applied.
21 Board Flex [AEC-Q200-005]	<p>Shall be pressurized at a speed of approx.0.5mm/sec in the direction indicated by the arrow until the bending width reaches 2mm and held for minimum 60sec.</p> 
22 Terminal Strength (SMD) [AEC-Q200-006]	<p>A R0.5 JIG shall be used to apply a 1.8kgf(17.6N) dead load in the direction indicated by the arrow to the element and retain it for 60sec</p> 
27 TEST NOT USED	-----
28 TEST NOT USED	-----
30 TEST NOT USED	-----

Remarks

For the criteria of group A, please refer to the following test measurement items.

Satisfying electrical performance. Shall be free from any defectiveness on its surface after the test. If there is no special requirement, firstly the x'tal unit go through twice reflow, then measured secondly, the x'tal units go through the test. thirdly after the test, the x'tal units are kept for more then 24 hours at room temperature (25°C) and humidity. Lastly, the measurement is carried out.

■ RELIABILITY SPECIFICATION

REFER TO Group B :
Reliability Test , Leak parameter , Drop test

ELECTRICAL & MECHANICAL PERFORMANCE

TESTING ITEM		TEST METHOD AND TEST CONDITION
1	Low Temperature Storage	Temperature : -40°C Time : 1000 hours
2	Sealing	a) Gross leak (Air leak test) b) Fine leak (Helium leak test) He-pressure : 6kgf/cm ² 2Hours.
3	Free Fall	Fall height : 150cm Weight : 50g Fall times : 10 times for Standard application. 100 times for Keyless entry On concrete plane.

Notes : TESTING ITEM 9 、 10 and 19 were tested in the process of manufacture.

Remarks

For the criteria of group B, please refer to the following test measurement items.
Satisfying electrical performance. Shall be free from any defectiveness on its surface after the test. If there is no special requirement, firstly the x'tal unit go through twice reflow, then measured secondly, the x'tal units go through the test. thirdly after the test, the x'tal units are kept for more then 24 hours at room temperature (25°C) and humidity. Lastly, the measurement is carried out.

■ SUGGESTED REFLOW PROFILE

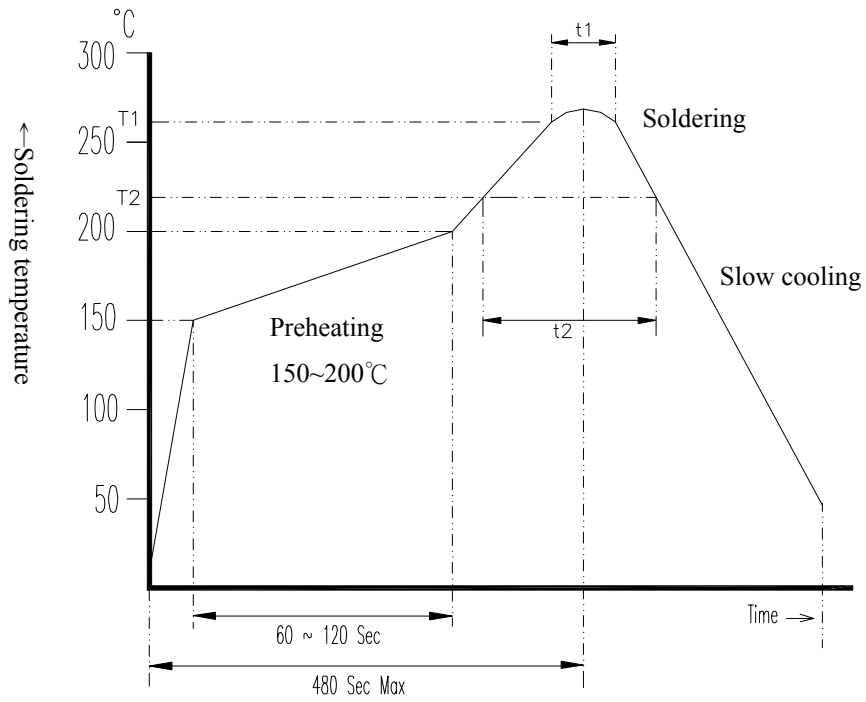

Application\Temperature Time	T1 / t1	T2 / t2
Lead Free	260±5°C / 10±5 Sec Max	217°C Min / 60~150 Sec
Non Lead Free	240±5°C / 10±5 Sec Max	183°C Min / 60~150 Sec

■ PACKING

Unit: mm

1. CARRIER TYPE

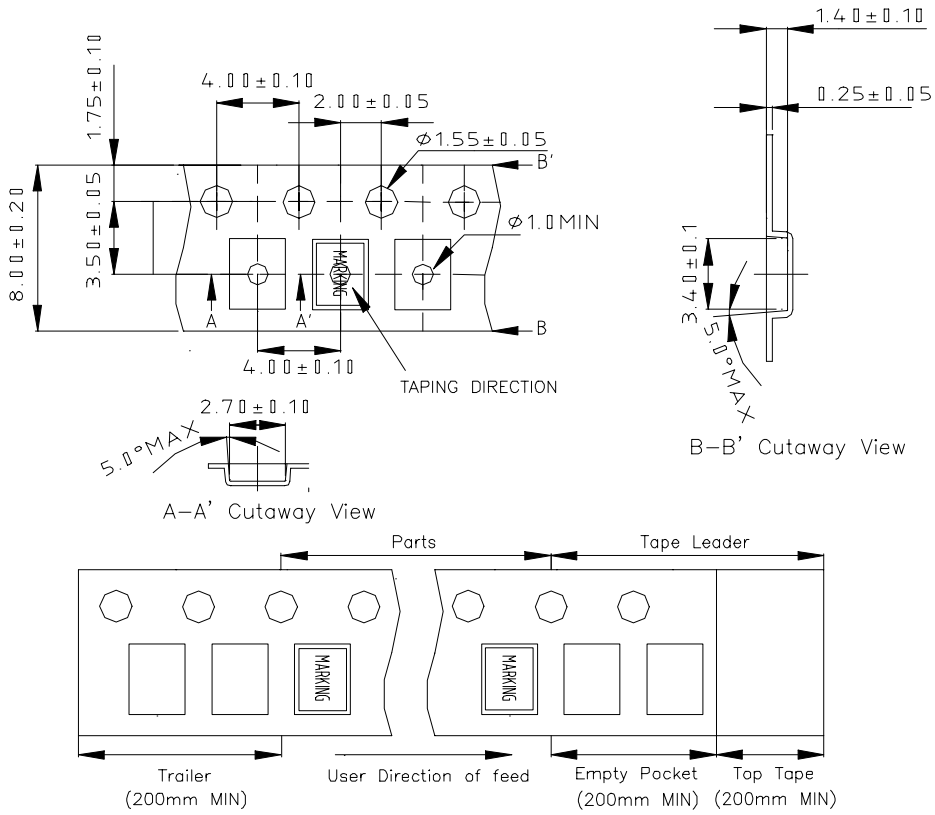

2. REEL : 3000 PCS

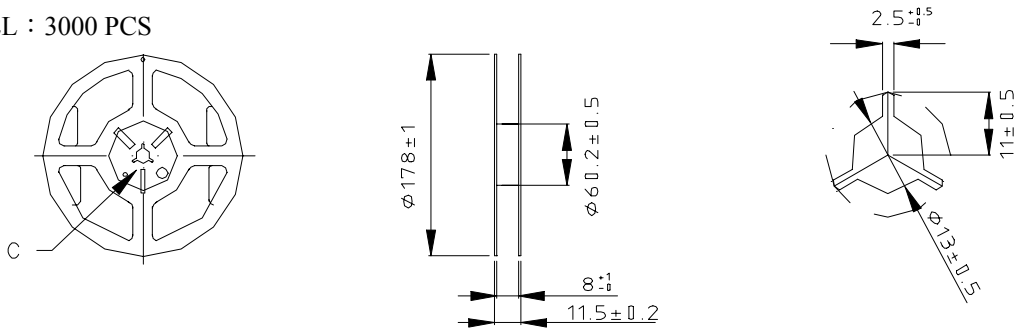

3. LABEL

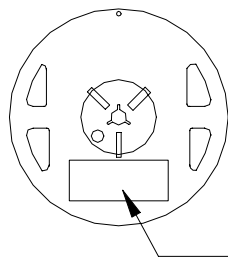

CUSTOMER:		
FREQ :		QC
TYPE :		OK
SPEC :		Pb
P.O.:		HF
CUST.P/N.:		
LOT NO.:		
MFG.P/N.:		
D.C.:	QTY.:	RoHS

SIWARD